



PEUGEOT 307 htb.  
PEUGEOT 308 htb.

05/2001-09/2007  
10/2007-08/2013

Cat. No. **P/021**

**E20**

E20 55R-01-1447

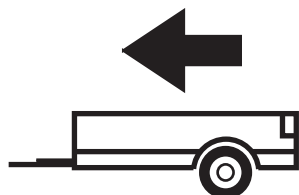

1500kg

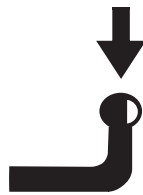

60kg

**D** = 8,06kN

**D (kN) =**



MAX kg

x

MAX kg

x 0,00981



MAX kg

+

MAX kg



IMIOLA HAK-POL

96-111 KOWIESY, CHOJNATA 23A, POLAND

Tel. + 48 46 831 73 31, fax +48 831 74 29

e-mail: office@imiola.pl, www.imiola.pl

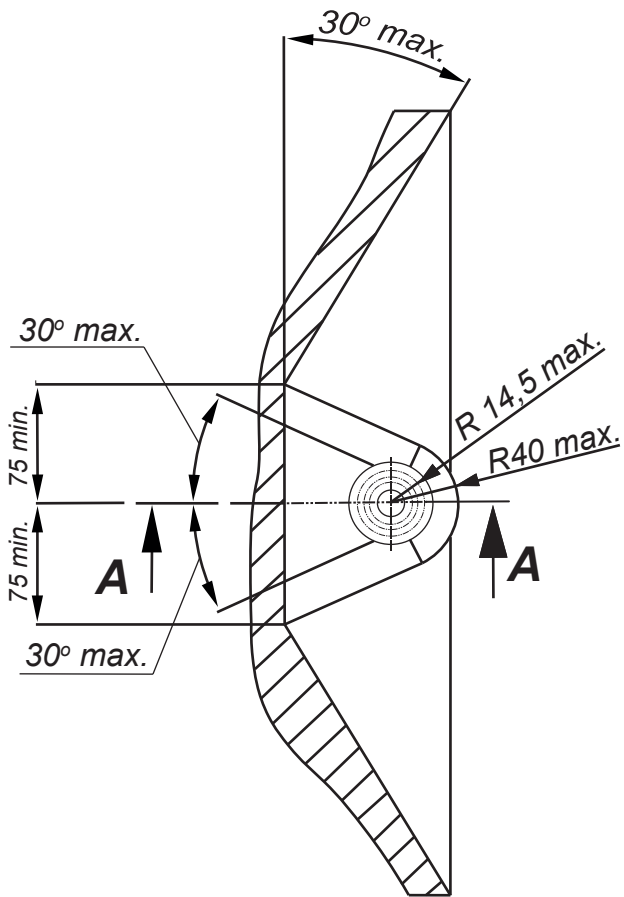

### PRZEKRÓJ A-A

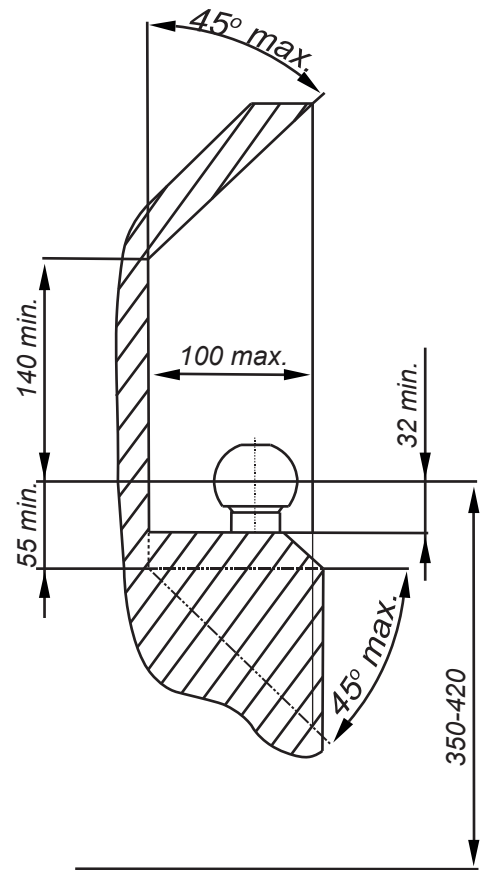

**PL** Należy zagwarantować przestrzeń swobodną według załącznika VII, rysunek 25a/b Regulaminu EKG ONZ 55.01 przy dopuszczalnym ciężarze całkowitym pojazdu.

**F** L'espace libre doit être garanti conformément à l'annexe VII, illustration de la réglementation 55.01 CE pour un poids total en charge autorisé du véhicule.







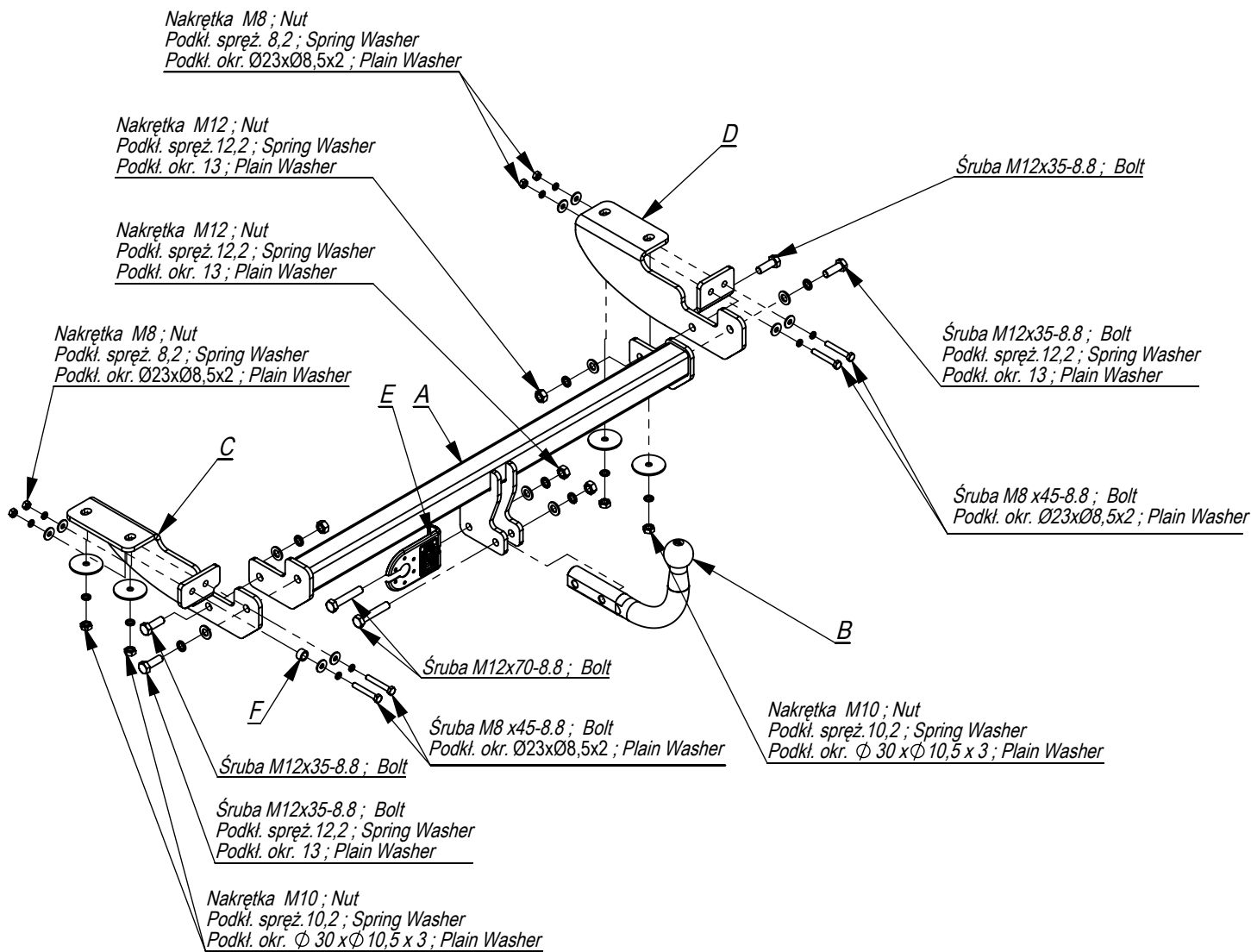

**GB** The clearance specified in appendix VII, diagram 25a/b of Regulation No. 55.01 UN EU must be guaranteed at laden weight of the vehicle.

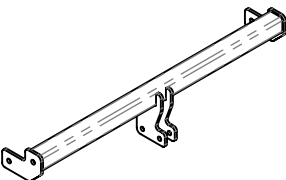
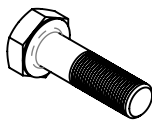
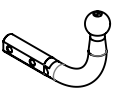
**D** Der Freiraum nach Anhang VII, Abbildung 25a/b der Vorschriften 55.01 EG ist zu gew 25a/bahrleisten bei zulässigem Gesamtgewicht des Fahrzeuges.

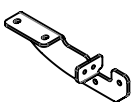
Moment skręcający dla śrub i nakrętek (8.8) Torque settings for nuts and bolts (8.8)	
M8	25Nm
M10	55Nm
M12	85Nm
M14	135Nm
M16	195Nm

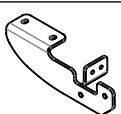



	A	x1		M12x70	2
				M12x35	4
				M8x45	4
	B	x1		M12	4
				M10	4
				M8	4
	C	x1		Ø30xØ10,5x3	4
				Ø23xØ8,5x2	8
	D	x1		13	6
				12,2	6
	E	x1		10,2	4
				8,2	4
	F	x1			
Ø18x2x10					

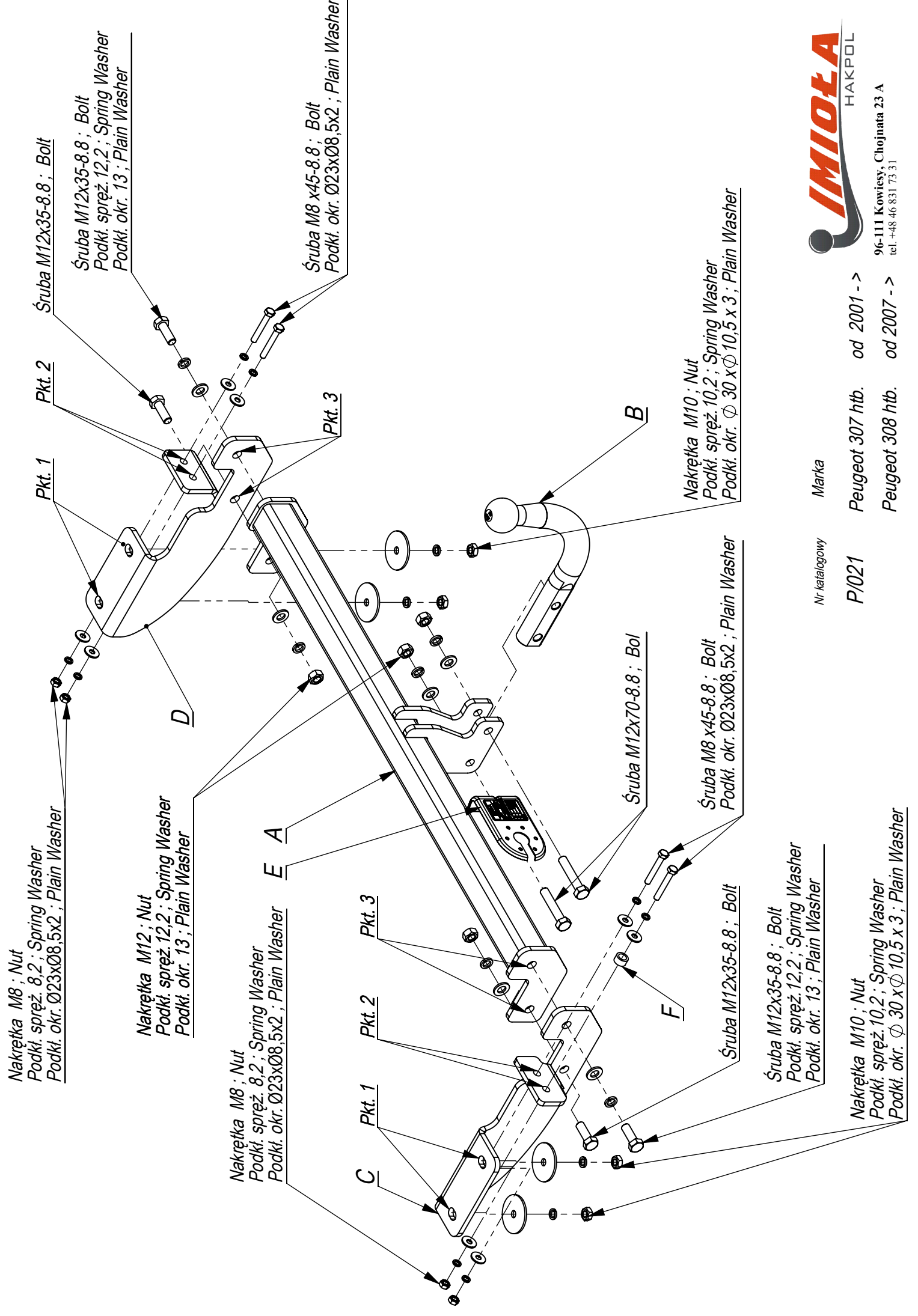

96-111 Kowiesy, Chojnata 23 A  
tel. +48 46 831 73 31

Nr katalogowy	Marka	Peugeot 307 htb.	Peugeot 308 htb.
P/021		od 2001 ->	od 2007 ->

- Odkręcić zderzak.
- Od tylnego pasa odkręcić belkę zderzeniową (nie będzie już wykorzystana).
- Elementy zaczepu C i D przykręcić lekko do podłużnic, na wystające śruby nakrętkami M10 (pkt 1) oraz do tylnego pasa śrubami M8x45 8.8 (pkt 2).
- Do elementów zaczepu C i D przykręcić belkę zaczepu A śrubami M12x35 8.8 (pkt 3).
- Dokręcić wszystkie śruby z momentem wg tabeli.
- Przykręcić zderzak.
- Przykręcić kulę i blachę gniazda elektrycznego.
- Podłączyć instalację elektryczną.

- Unscrew the bumper.
- Unscrew the bumper bar from the rear belt (it will not be used any more).
- Screw slightly the elements C and D to the metal clamps, on the protruding bolts with nuts M10 (point 1) and to the rear belt with bolts M8x45 8.8 (point 2).
- Screw the main bar A to the elements C and D with bolts M12x35 8.8 (point 3).
- Tighten all the bolts according to the torque setting- see the table.
- Screw the bumper.
- Fix the ball and electric plate.
- Connect the electric wires.

- Dévisser le pare-chocs
- Déposer le butoir de l'ail arriere de voiture, (il ne sera plus utilisé).
- Serrez legerement les éléments du crochet C et D aux longerons par boulons avec des ecrous M10 (point 1) et a la ceinture arri?re par les boulons M8x45 8.8 (point 2).
- Serrez les ocle du Rochet A au Rochet C et D par les boulons M12x35 8.8 (point 3).
- Serrer tous les boulons avec un couple de serrage selon tableau.
- Serrez le pare-choc.
- Visser le crochet d'attelage et socle de prise électriquepar.
- Raccorder le circuit électrique.

- Die Anhängerkupplung abschrauben.
- Von dem hinteren Karosseriestreifen den Stoßbalken abschrauben, wird nicht wieder gebraucht.
- Die Tragteile C und D an die Längsträger auf die herausragenden Schrauben mit den Muttern M10 (Punkt 1) und an den hinteren Karosseriestreifen mit den Schrauben M8x45 8.8 (Punkt 2) locker anschrauben.
- An die Tragteile C und D den Querbalken A mit den Schrauben M12x35 8.8 (Punkt 3) anschrauben.
- Alle Schrauben mit dem in der Tabelle angegebenen Drehmoment festziehen.
- Die Stoßstange anschrauben.
- Die Kugel und die Steckdosenhalterung mit den anschrauben.
- Die Elektroinstallation anschließen.

- Desenrosque el parachoques.
- Desenrosque la barra de impacto (ya no es necesario).
- Fijar los elementos C y D a los largueros con tuercas M10 (punto 1) y a la correa trasera con tornillos M8x45 (punto 2).
- Apretar una barra el ganchode remolque A con los tornillos M12x35 8.8 (punto 3).
- Apretar todos los tornillos con el par según la tabla anterior.
- Fijar el parachoques.
- Atornille la bola y la placa de toma de corriente eléctrica. con tornillos M12x70 8.8.
- Conectar la instalación eléctrica.

