



06/2013 -

TOYOTA COROLLA 4D (E18)

Cat. No. T/061

E20

E20 55R-01 5038

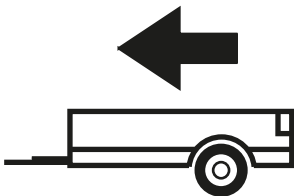

1300kg

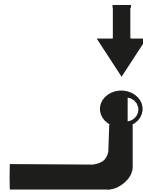

60kg

D = 8,60kN

D (kN) =



MAX kg

x

MAX kg

x 0,00981



MAX kg

+

MAX kg



IMIOLA HAK-POL

96-111 KOWIESY, CHOJNATA 23A, POLAND

Tel. + 48 46 831 73 31, fax +48 831 74 29

e-mail: office@imiola.pl, www.imiola.pl

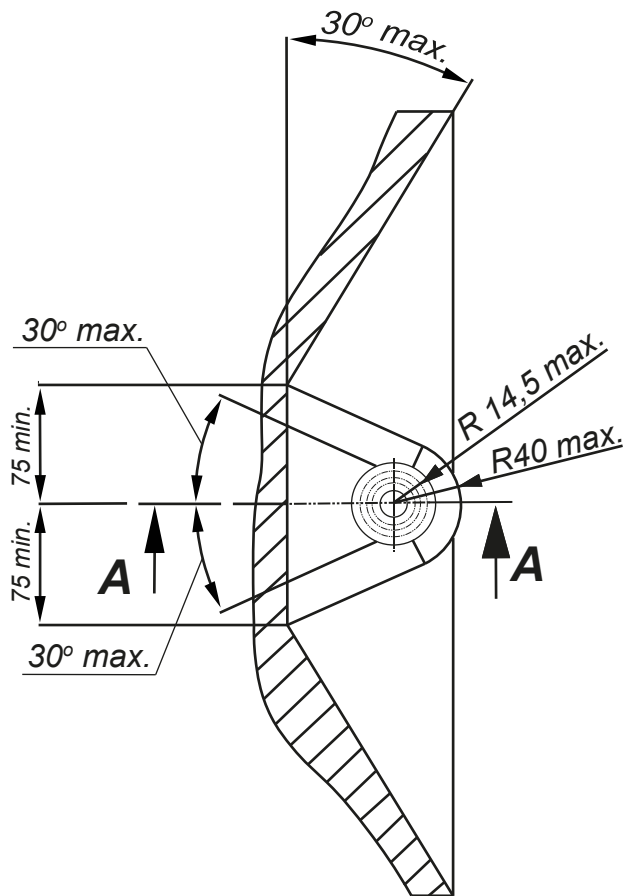

PRZEKRÓJ A-A

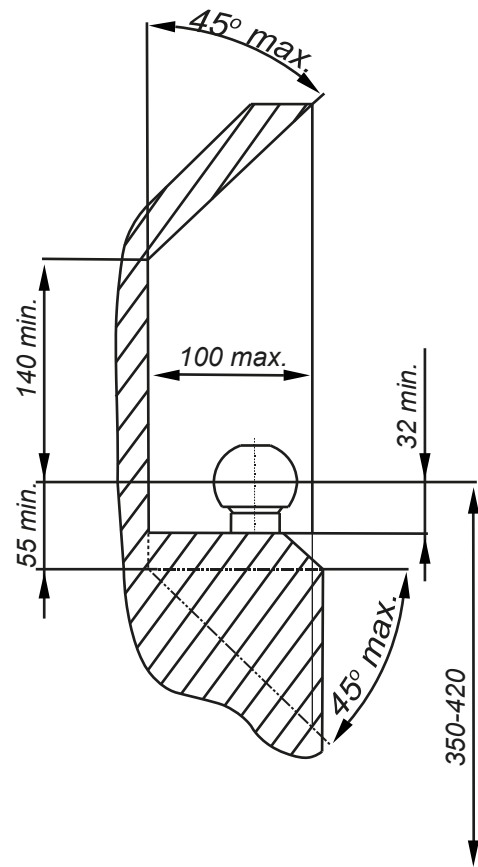

PL Należy zagwarantować przestrzeń swobodną według załącznika VII, rysunek 25a/b Regulaminu EKG ONZ 55.01 przy dopuszczalnym ciężarze całkowitym pojazdu.

F L'espace libre doit être garanti conformément à l'annexe VII, illustration de la réglementation 55.01 CE pour un poids total en charge autorisé du véhicule.







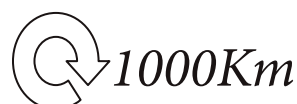

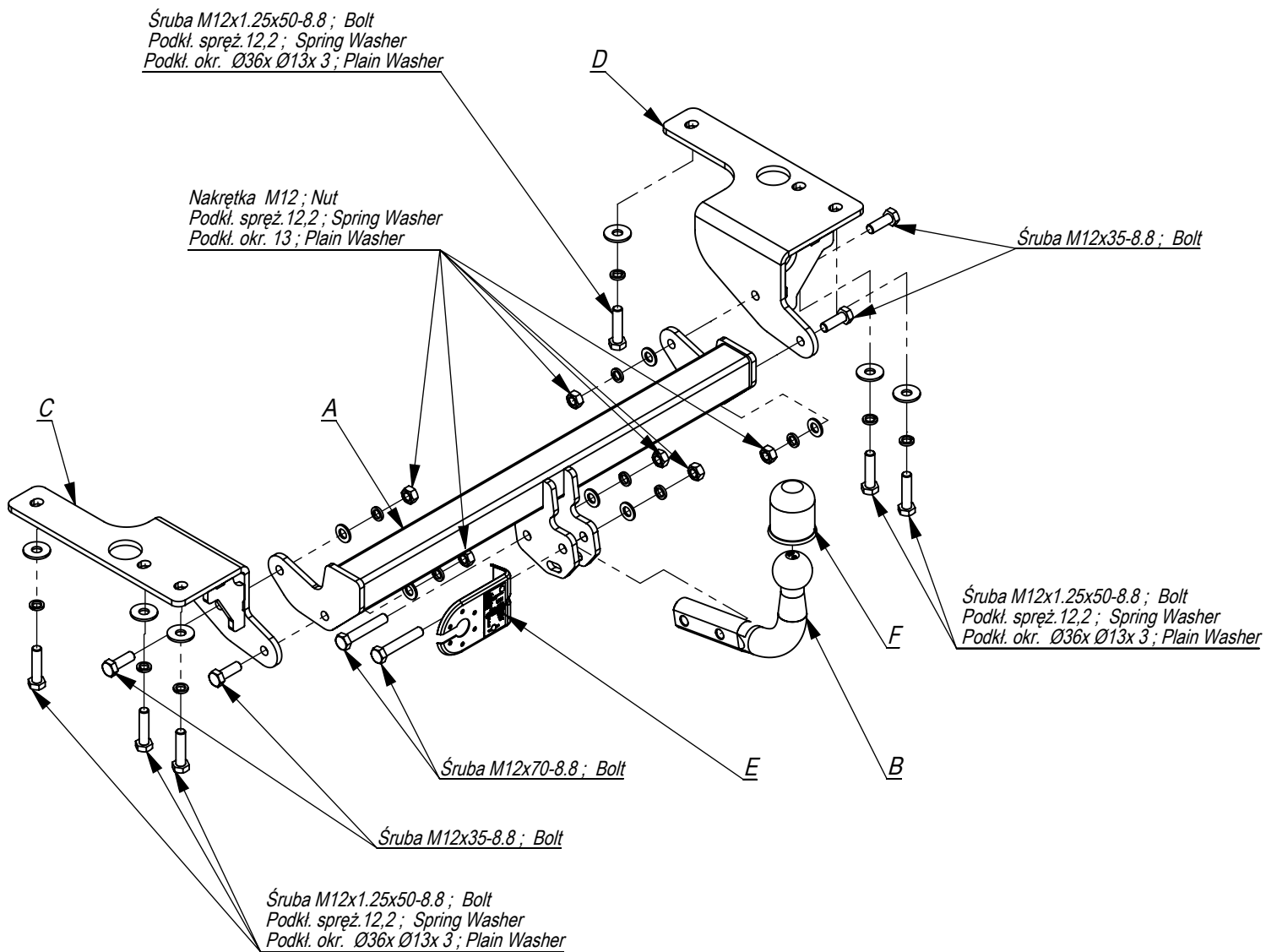
GB The clearance specified in appendix VII, diagram 25a/b of Regulation No. 55.01 UN EU must be guaranteed at laden weight of the vehicle.

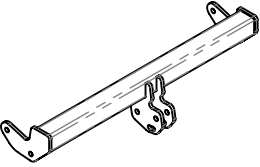
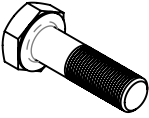
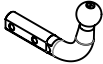
D Der Freiraum nach Anhang VII, Abbildung 25a/b der Vorschriften 55.01 EG ist zu gew 25a/b abzuwehren bei zulässigem Gesamtgewicht des Fahrzeuges.

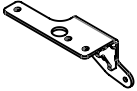
Moment skręcający dla śrub i nakrętek (8.8) Torque settings for nuts and bolts (8.8)	
M8	25Nm
M10	55Nm
M12	85Nm
M14	135Nm
M16	195Nm

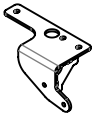



	A	x1		M12x1,25x50	6
				M12x70	2
				M12x35	4
	B	x1		M12	6
	C	x1		Ø36xØ13x3	6
	D	x1		13	6
	E	x1		12,2	12
	F	x1			

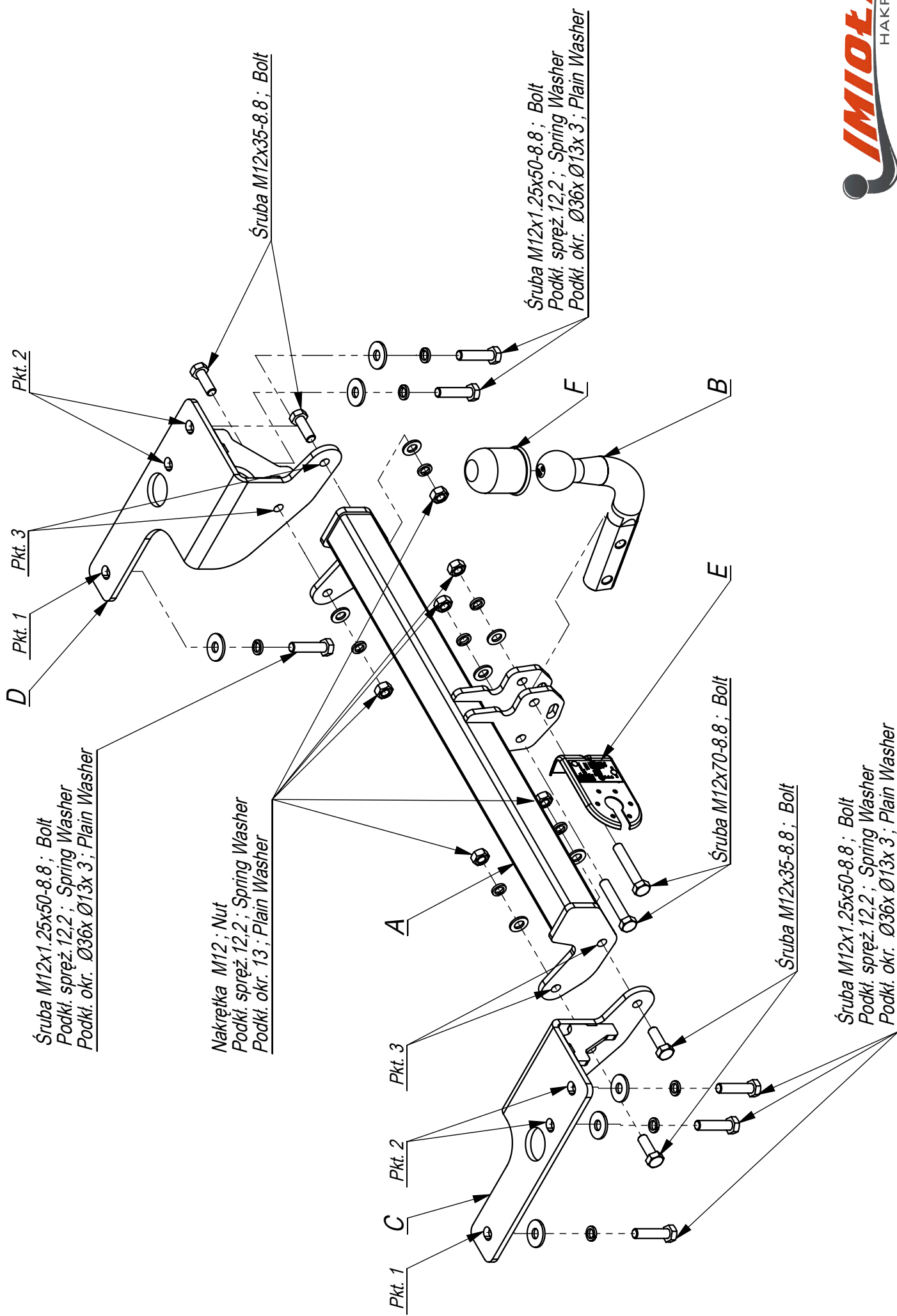

Śruba M12x1.25x50-8.8; Bolt
Podkl. spręż. 12.2; Spring Washer
Podkl. okr. Ø36x Ø13x 3; Plain Washer

Nakrętka M12; Nut
Podkl. spręż. 12.2; Spring Washer
Podkl. okr. 13; Plain Washer

Śruba M12x35-8.8; Bolt

Śruba M12x1.25x50-8.8; Bolt
Podkl. spręż. 12.2; Spring Washer
Podkl. okr. Ø36x Ø13x 3; Plain Washer

Śruba M12x70-8.8; Bolt

Śruba M12x35-8.8; Bolt

Śruba M12x1.25x50-8.8; Bolt
Podkl. spręż. 12.2; Spring Washer
Podkl. okr. Ø36x Ø13x 3; Plain Washer



Nr katalogowy T/061
Marka Toyota

Toyota Corolla 4D (E18) od 06/13 ->

96-111 Kowiesy, Chojnata 23 A
tel. +48 46 831 73 31

- Odkręcić osłonę plastikową w tylnej części samochodu oraz ucho holownicze z lewej strony.
- Przykręcić elementy haka C i D do podłużnic samochodu śrubami M12x1,25x50 8.8 (pkt 1,2).
- Przykręcić belkę zaczepu A do elementów C i D śrubami M12x35 8.8 (pkt 3).
- Przykręcić kulę i blachę gniazda elektrycznego śrubami M12x70 8.8.
- Dokręcić wszystkie śruby z momentem według tabeli.
- Podłączyć instalację elektryczną.

- Unscrew the plastic shield in the rear part of the car and towing eye from the left.
- Screw the elements C and D to the metal clamps with bolts M12x1,25x50 8.8 (point 1,2).
- Screw the the main bar A to the elements C and D with bolts M12x35 8.8 (point 3).
- Fix the ball and electric plate with bolts M12x70 8.8.
- Tighten all the bolts according to the torque setting- see the table.
- Connect the electric wires.

- Dévisser la protection en plastique dans la partie arrière de la voiture et l'anneau de remorquage du côté gauche.
- Visser les éléments C et D aux longerons avec les boulons M12x1,25x50 8.8 (point 1,2).
- Visser la poutre du crochet d'attelage aux éléments C et D avec les boulons M12x35 8.8 (point 3).
- Visser la boule et la tôle de la prise électrique avec les boulons M12x70 8.8.
- Serrer tous les boulons avec un couple de serrage selon tableau.
- Brancher l'installation électrique.

- Schrauben Sie die Plastikabdeckung an der Rückseite des Autos und die Abschleppöse auf der linken Seite ab.
- Die AHK-Bauteile C und D mit Schrauben M12x1,25x50 8.8 (Punkt 1,2) an den Längsträgern festschrauben.
- Den Träger von Haken A an die Bauteile C und D mit Schrauben M12x35 8.8 (Punkt 3) anschrauben.
- Schrauben Sie die Kugel und den Steckdosenblech mit den Schrauben M12x70 8.8 an.
- Ziehen Sie alle Schrauben mit dem Drehmoment gemäß der Tabelle an.
- Die Elektroinstallation anschließen..

- Desatornille la cubierta de plástico en la parte posterior del automóvil y la argolla de remolque a la izquierda.
- Fijar los elementos C y D del gancho a los largueros con tornillos M12x1,25x50 (punto 1,2).
- Fijar el gancho A a los elementos C y D con tornillos M12x35 8.8 (punto 3).
- Atornille la bola y la placa de toma de corriente eléctrica. con tornillos M12x70 8.8.
- Apretar todos los tornillos con el par según la tabla anterior.
- Conectar la instalación eléctrica.

